



EstesRockets.com

SOLAR TWIRL™

1323

AGES
10+



Skill Level

BEGINNER

MODEL ROCKET INSTRUCTIONS

KEEP FOR FUTURE REFERENCE

IMPORTANT: Please record date found on decal and keep for future reference. _____

READ ALL INSTRUCTIONS. Make sure you have all parts and supplies. Test fit all parts before applying glue. Refer to your glue manufacturer's dry times during build.

SUPPLIES



YELLOW GLUE



PLASTIC CEMENT



PENCIL

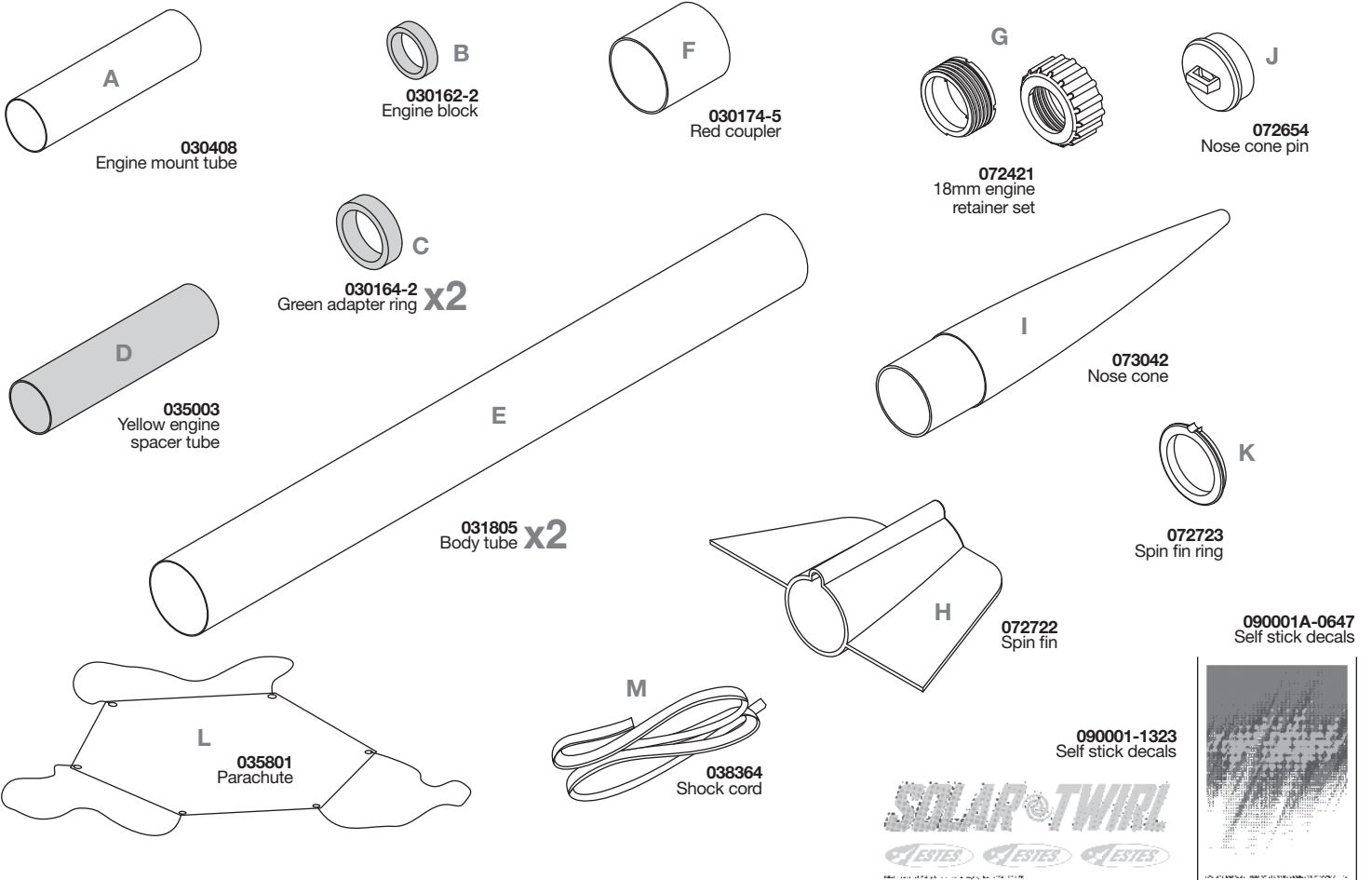

ASSEMBLE ENGINE MOUNT

1. Make a pencil mark 1/4 in. from end of yellow engine spacer tube **D**.

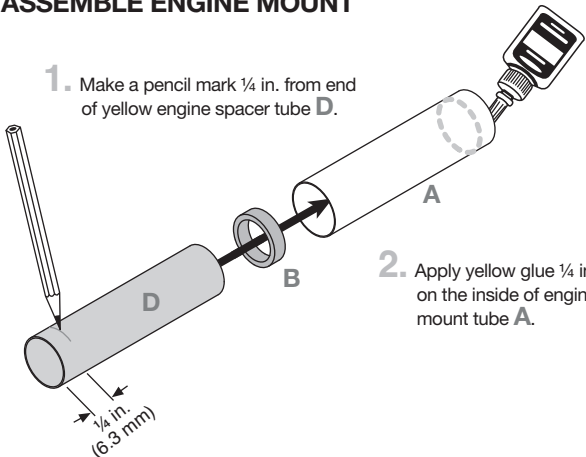

2. Apply yellow glue 1/4 in. on the inside of engine mount tube **A**.

3. Insert engine block **B** into engine mount tube **A**. Insert yellow spacer tube **D** up to the pencil mark to push the engine block in place.

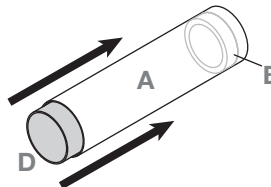

4. Quickly remove yellow spacer tube **D**.

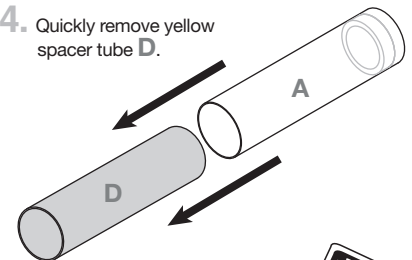

5. Apply yellow glue 1/4 in. from end of engine tube **A**.

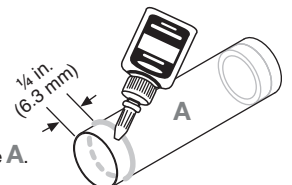

ASSEMBLE ENGINE MOUNT (continued)

6. Place green adapter ring **C** onto the end of engine tube **A** using engine retainer **G** (notched side facing towards engine tube) to set the distance.

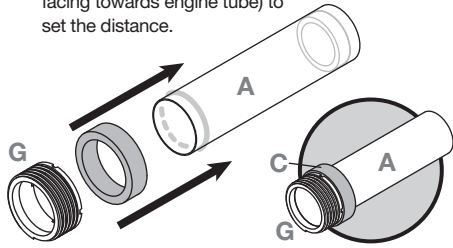

7. Remove engine retainer **G**.

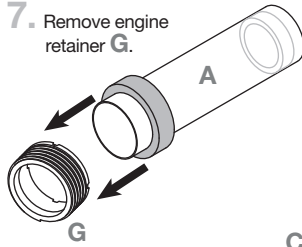

8. Apply yellow glue to the end of engine tube **A** that has the engine block.

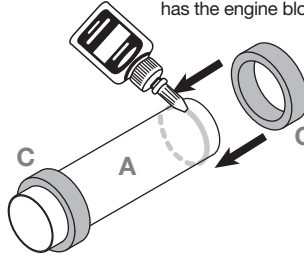

9. Place the other green adapter ring **C** onto the end of engine tube **A**.

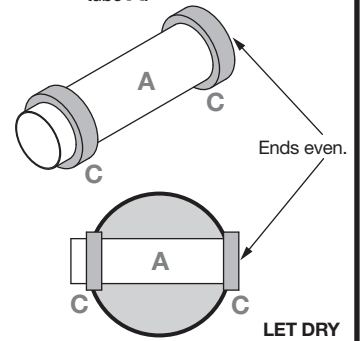

ASSEMBLE BODY

1. Apply yellow glue to inside of body tube **E**. If need be, use a stick to apply glue 2 in. deep.

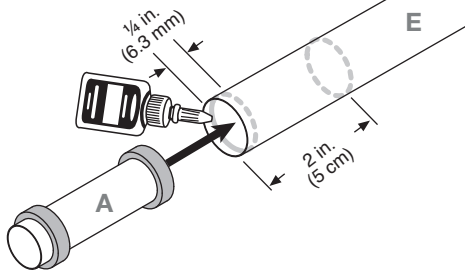

2. Insert engine mount assembly into body tube **E**. Ensure that the end of the green adapter **C** is even with the end of body tube **E**.

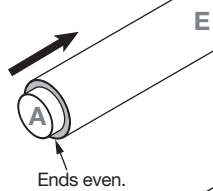

3. Apply yellow glue to inside of the opposite end of body tube **E**.

CAUTION:
For safe handling of plastic cement, see manufacturer's warnings and follow instructions for use.

4. Mark red coupler **F** with pencil in the center. Insert red coupler **F** into Tube **E** up to the marked center line.

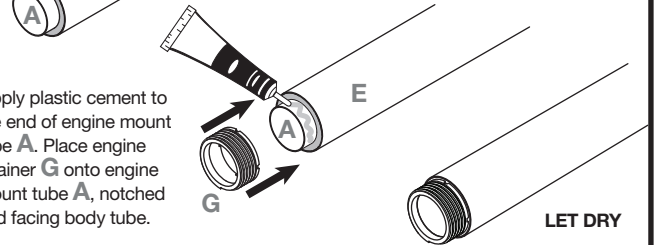

5. Apply yellow glue to the inside of the second body tube **E**. Insert red coupler **F** into second body tube **E**. Fit both body tubes together tightly.

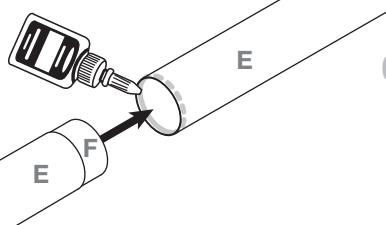

ASSEMBLE NOSE CONE

1. Apply plastic cement to inside of nose cone **I**.

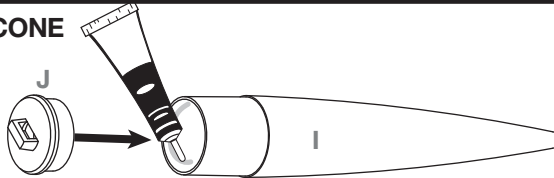

2. Insert nose cone pin **J** nose cone **I**.

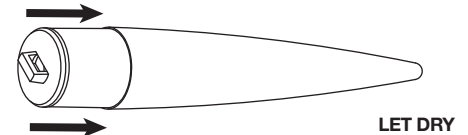

INSTALL SHOCK CORD / PARACHUTE ATTACHMENT

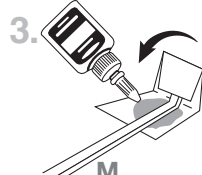
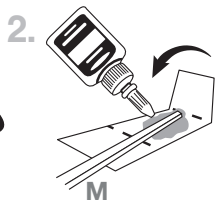
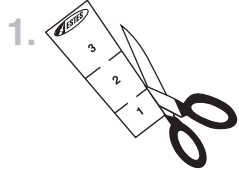

4. Hold until set.



5. Hold until set.

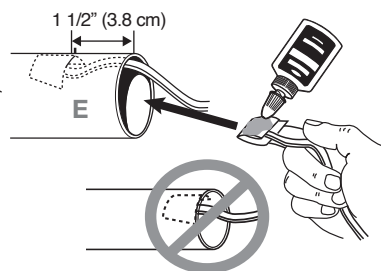

Shock cord mount:
Make a copy if you want to keep instructions.

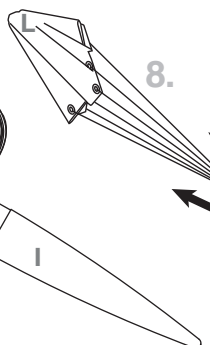
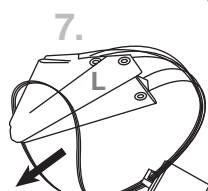
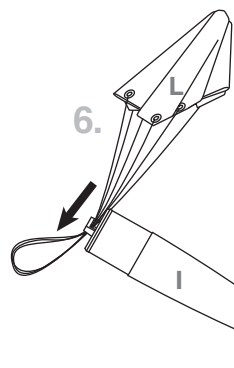

9. Tie other end of shock cord **M** to nose cone pin **J** using a double knot.

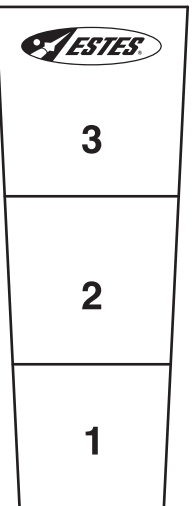

FIN PREPARATION

1. Apply plastic cement to back ring edge of fin H.

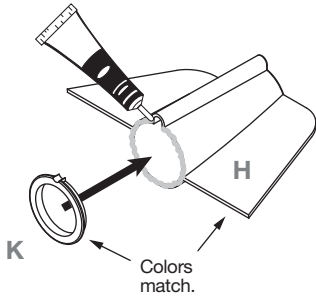

2. Place fin ring K onto to back ring edge of fin H.

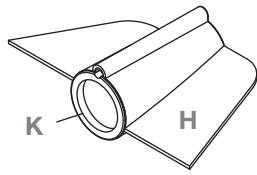

LET DRY

3. Slide completed fin unit onto E until it stops.

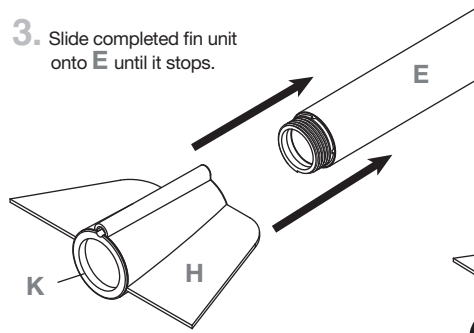

4. Secure H onto E with G.

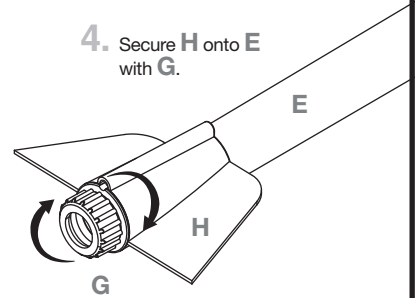

APPLY STICKERS

Apply stickers.

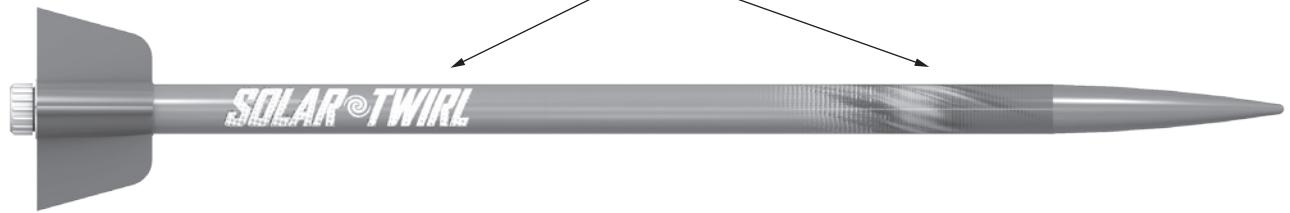

PREPARE FLIGHT RECOVERY

1. Push recovery wadding down towards end of the body tube.

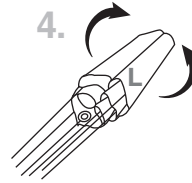
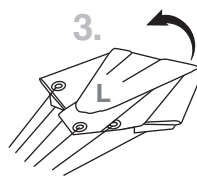
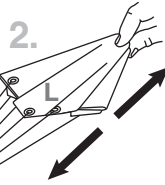
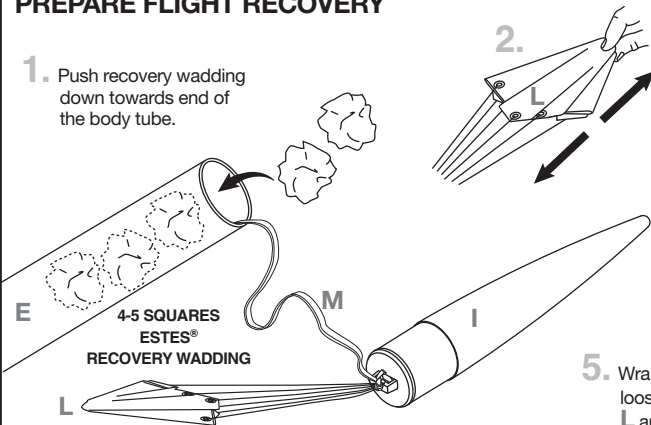

5. Wrap parachute shroud lines loosely around the parachute L and insert into body tube E.

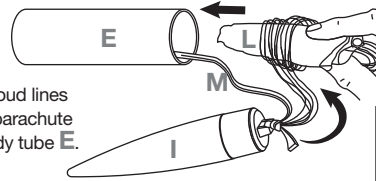

IF NOSE CONE FIT IS...

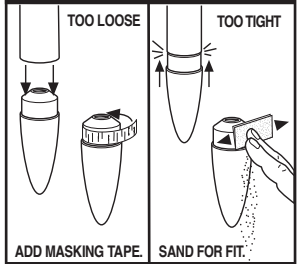

NOTE:

Recovery wadding and parachute must slide easily into body tube. If too tight, redo.

PREPARE ENGINE

1. Use one each.

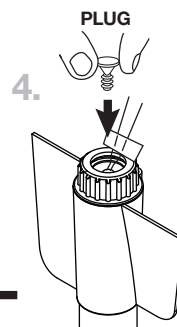
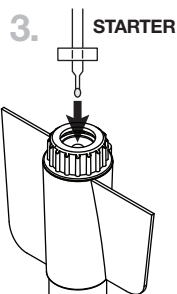
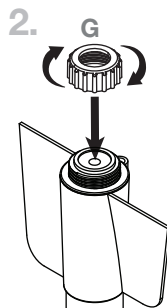
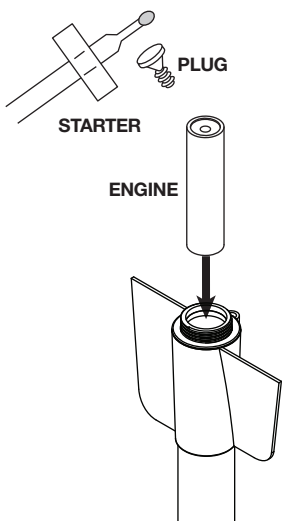

TIP MUST TOUCH PROPELLANT!

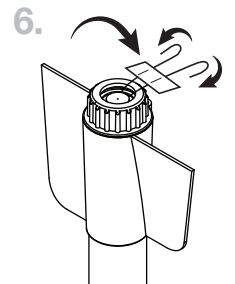
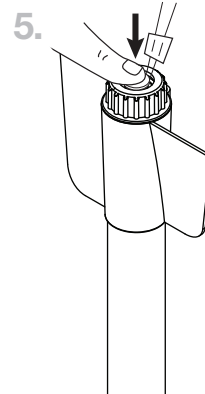

⚠ WARNING: FLAMMABLE

To avoid serious injury, read instructions & NAR Safety Code included with engines. **PREPARE YOUR ENGINE ONLY WHEN YOU ARE OUTSIDE AT THE LAUNCH SITE PREPARING TO LAUNCH.** If you do not use your prepared engine, remove the starter before storing your engine.

COUNTDOWN AND LAUNCH

NOTE:

Always keep the key **OUT** until final countdown.

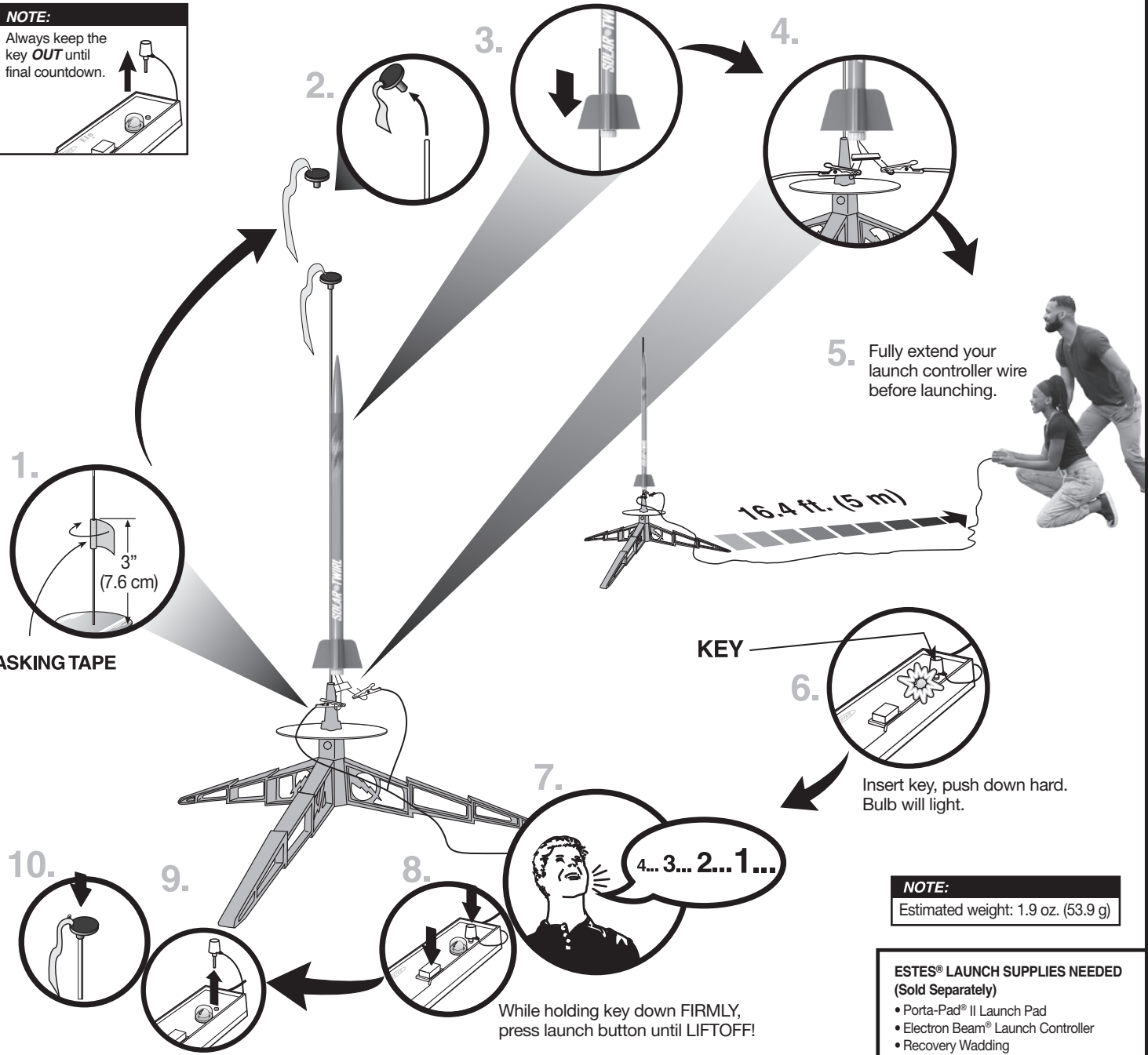

NOTE:

Estimated weight: 1.9 oz. (53.9 g)

ESTES® LAUNCH SUPPLIES NEEDED (Sold Separately)

- Porta-Pad® II Launch Pad
- Electron Beam® Launch Controller
- Recovery Wadding
- Starters (with engines)
- Plugs (with engines)
- Estes® Engines: B4-4, B6-2, B6-4, C5-3, C6-3

PRECAUTIONS



NAR SAFETY CODE



NO DRY GRASS OR WEEDS

PRE-LAUNCH CHECK For safety, never launch a damaged rocket. Check the rocket's body, nose cone and fins. Also, check the engine mount, recovery system and launch lug(s). Repair any damage before launching the rocket.

FLYING YOUR ROCKET Choose a large field (500 ft. [152 m] square) free of dry weeds and brown grass. The larger the launch area, the better your chance of recovering your rocket. Launch only with little or no wind and good visibility. Always follow the National Association of Rocketry (NAR) SAFETY CODE (enclosed).

MISFIRES TAKE THE KEY OUT OF THE CONTROLLER. WAIT ONE MINUTE BEFORE GOING NEAR THE ROCKET. Disconnect the micro-clips and remove the engine. Take the plug and starter out of the engine. A burned starter means the starter tip was not touching engine propellant. Install a new starter; be sure the tip is touching propellant inside the engine. Push the plug in place. Repeat steps under Countdown and Launch.

